

ARCHITECTURAL LIGHTING SOLUTIONS

Premium Linear Led Lighting



Sales Office:
Plot No. D-46, Neb Sarai, IGNOU Road, (Near Gate No. 4 of Freedom Fighter Enclave), New Delhi-110068 (INDIA)

Mail Us: business@indiaals.com • sales@indiaals.com
info@indiaals.com • siddhant@indiaals.com

Mobile No.: Sales: +91-7330303060, 7330303040, 7330303010
Technical Info.: +91-9999999002 | Projects: +91-7330505050



INTRODUCTION

Architectural Lighting Solutions (ALS) is a market leader which cater to demand of premium linear led lighting. ALS has the largest range in anodized aluminum profile made in India.

ALS manufactures and markets technically up market linear profiles matching aesthetics and quality norms of the best European fixtures available in Indian markets. The company employs full time technical staff, supported by excellent workshop and warehousing facilities.

ALS has successfully completed many prestigious projects during its existence, working on pan – India basis, apart from a network of dealers. Changing concepts to reality has been the forte of ALS – this all comes with competitive pricing, unprotected deliveries and excellent post sales services – creating a win-win situation for all.

ALS enjoys a good reputation among architects, interior designers, lighting consultants and specifiers.



PREMIUM LINEAR LED LIGHTING

INDEX

PREMIUM LINEAR LED LIGHTING

INDEX



MICRO SM0809
01



MICRO RM0809 TRIM
01



MICRO SM1013
02



MICRO RM1013 TRIM
02



MICRO SM1214
03



MICRO RM1214 TRIM
03



BEND 1806
04



BEND PMMA 1018 SIDE VIEW
04



BEND 1413 TOP VIEW
04



POP FLAT 1214
05



POP CORNER IN 1214
05



POP CORNER OUT 1214
06



POP COVE MICRO 1035
07



POP WINGS 2525
07



POP WINGS 3535
08



POP WINGS 5035
08



LP 0101
09



LP 0102
09



LP 0103
10



LP 0104
10



LP 0105
11



LP 0106
11



LP 0107
12



LP 0108
12



LP 0201
13



LP 0205
13



LP 0202 R / LP 0202 S
14



LP 0204 R / LP 0204 S
14



LP 0301 (TRIPLE)
15



ALS HANGER ROD
15



ALS RETAIL SURFACE
16



ALS RETAIL RECESSED-01
16

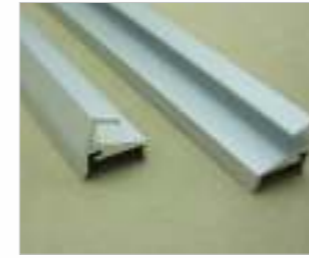

ALS RETAIL GLASS MOUNTED-01
17



ALS GLASS SHELF RECESSED
17



ALS GLASS SHELF SURFACE
17

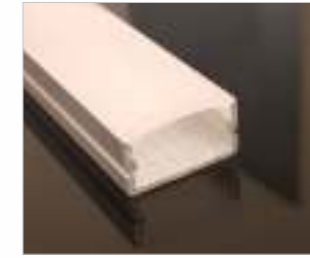

ECO 2512
19

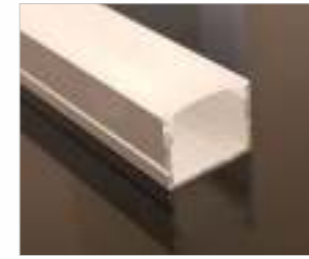

ECO 2518
20

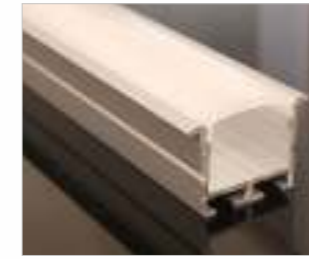

ECO 2520 TRIM
20



ECO 3535
21



ECO 3535 TRIM
21



ECO 5035
22

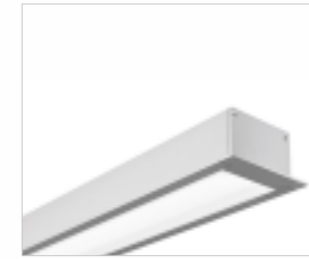

ECO 5035 TRIM
22

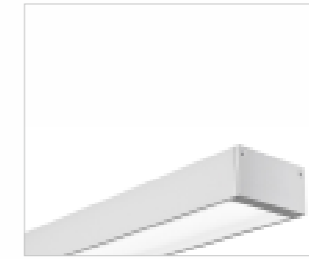

ECO 7535
23



ECO 7575 TRIM
23



ECO 5070 3D
24



ECO 5070 FLAT
24



ECO 7090
25

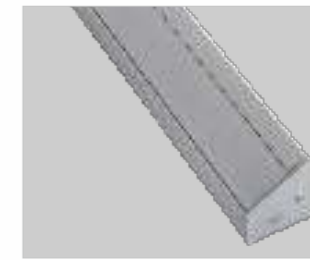

CORNER 30°
27

PREMIUM LINEAR LED LIGHTING

INDEX

PREMIUM LINEAR LED LIGHTING

INDEX

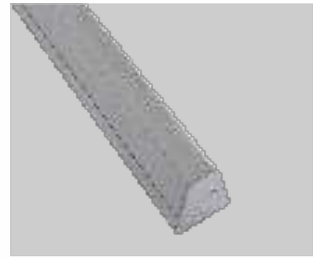

CORNER 60°
27



WALL WASHER ASYMMETRIC RECESSED
28



WALL WASHER ASYMMETRIC SURFACE
28



BIG CORNER 5050
29



LINEA 3050 TRIM
40



LINEA 5050
41



LINEA 5050 TRIM
41



LINEA 6080
42



WALL LIGHT LP 0501
29



WALL LIGHT LP 0502
30



WALL LIGHT LP 0503
30



WALL UP DOWN
31



LINEA 7780 TRIM
42



LINEA 4848
43



LINEA 4870
43



LINEA 48100 UP DOWN
44



HAND RAILING
31



ALS FOOT LIGHT LP 0701
32



ALS STEP LIGHT LP 0702
32



ALS SKIRTING 50MM LP 0703
33



LINEA 90100
45

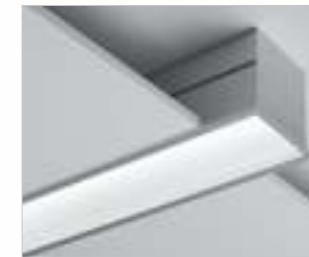

LINEA 112100 TRIM
45

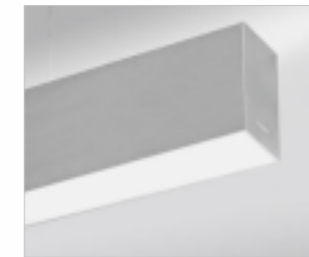

LINEA 90136 UP DOWN
46



LINEA 13590
46



SKIRTING WALL WASH LP 0704
33



ALS COVE LP 0901
34



ALS DEEP COVE LP 0903
34



ALS 2525 3D
35



LINEA 10020 UP DOWN SUSPENDED
47



GLOW 3D
47



RIM PROFILE
49



SHELF PROFILE MINI
50



WALL UP-DOWN LP 0505
35



FLOOR INDOOR SMALL
36



FLOOR INDOOR BIG
36



LINEA 1530
38



EDGE PROFILE-RECESSED
50



EDGE PROFILE-SINGLE-SIDED
51



EDGE PROFILE-SINGLE-SIDED
51



EDGE PROFILE-DOUBLE-SIDED
52



LINEA 1525 TRIM
38



LINEA 2525
39



LINEA 2530
39

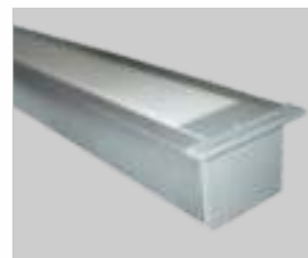

LINEA 2525 TRIM
40



EDGE PROFILE-DOUBLE-SIDED
52



EDGE PROFILE-SINGLE-SIDED, NARROW
53



EDGE PROFILE-DOUBLE-SIDED, NARROW
53



ENCAPSULATED IP RATED LINEAR LED LIGHTS
54-56

Micro

Specifications

Material: Anodized Aluminum
 Diffuser: Clear/ Opal or Frosted Polycarbonate
 Dimension: W: 8mm, H: 9mm
 Light Source: 5mm LED Strip
 Installation: Surface Mounted
 Available Length: 3 meter

Dimension

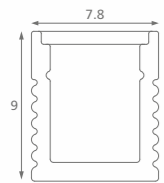

Accessories



End Cap



Mounting Clip

MICRO SM0809



Micro

Specifications

Material: Anodized Aluminum
 Diffuser: Clear/ Opal or Frosted Polycarbonate
 Dimension: W: 10mm, H: 13mm
 Light Source: 8mm LED Strip
 Installation: Surface Mounted
 Available Length: 3 meter

Dimension

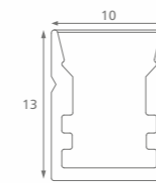

Accessories



End Cap



Mounting Clip

MICRO SM1013



Micro

Specifications

Material: Anodized Aluminum
 Diffuser: Clear/ Opal or Frosted Polycarbonate
 Dimension: W: 12mm (8mm), H: 9mm
 Light Source: 5mm LED Strip
 Installation: Recessed Mounted
 Available Length: 3 meter

Dimension

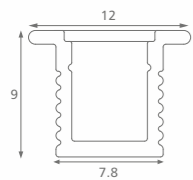

Accessories



End Cap

MICRO RM0809 TRIM



Micro

Specifications

Material: Anodized Aluminum
 Diffuser: Clear/ Opal or Frosted Polycarbonate
 Dimension: W: 14mm (10mm), H: 13mm
 Light Source: 8mm LED Strip
 Installation: Recessed Mounted
 Available Length: 3 meter

Dimension

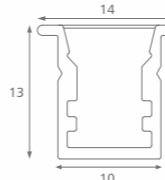

Accessories



End Cap

MICRO RM1013 TRIM



Micro

Specifications

Material: Anodized Aluminum
 Diffuser: Clear/ Opal or Frosted Polycarbonate
 Dimension: W: 12mm, H: 14mm
 Light Source: 8mm LED Strip
 Installation: Surface Mounted
 Available Length: 3.6 meter

Dimension

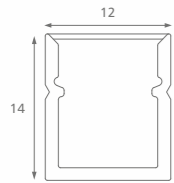

Accessories



End Cap



Mounting Clip

Micro

Specifications

Material: Anodized Aluminum
 Diffuser: Clear/ Opal or Frosted Polycarbonate
 Dimension: W: 16mm (12mm), H: 14mm
 Light Source: 8mm LED Strip
 Installation: Recessed Mounted
 Available Length: 3.6 meter

Dimension

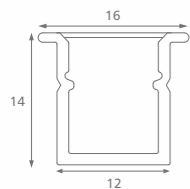

Accessories



End Cap

MICRO SM1214



MICRO RM1214 TRIM



Bendable Profile

Specifications

Material: Anodized Aluminum
 Diffuser: Milky Polycarbonate
 Dimension: W: 18mm, H: 6mm
 Light Source: 10mm LED Strip
 Installation: Surface Mounted
 Available Lengths: 3meter
 Max Bend Radius: 15.24cm

Dimension

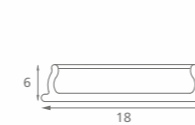

Accessories



End Cap



Mounting Clip

Bendable Profile

Specifications

Material: PVC & PU
 Dimension: W: 10mm, H: 18.5mm
 Light Source: 10mm LED Strip
 Installation: Surface Mounted
 Available Length: 5 meter/roll

Dimension



Accessories



End Cap



Mounting Clip

Bendable Profile

Specifications

Material: PU
 Dimension: W: 14mm, H: 13mm
 Light Source: 10mm LED Strip
 Installation: Surface Mounted
 Available Length: 5 meter/roll

Dimension



Accessories



End Cap



Mounting Clip

BEND 1806



BEND PMMA 1018 SIDE VIEW



BEND 1413 TOP VIEW



POP (Architectural)

Specifications

Material: Anodized Aluminum
 Diffuser: Clear/ Opal or Frosted Polycarbonate
 Light Source: 8mm LED Strip
 Installation: Recessed in Drywall
 Available Length: 3.6 meter

Dimension

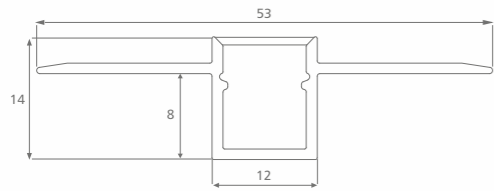

Accessories



End Cap

POP FLAT 1214



POP (Architectural)

Specifications

Material: Anodized Aluminum
 Diffuser: Clear/ Opal or Frosted Polycarbonate
 Light Source: 8mm LED Strip
 Installation: Recessed in Drywall
 Available Length: 3.6 meter

Dimension

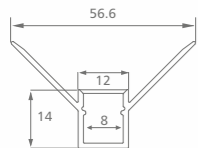

Accessories

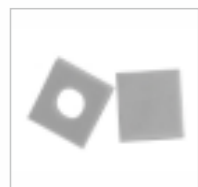

End Cap

POP CORNER IN 1214



POP (Architectural)

Specifications

Material: Anodized Aluminum
 Diffuser: Clear/ Opal or Frosted Polycarbonate
 Light Source: 8mm LED Strip
 Installation: Recessed in Drywall
 Available Length: 3.6 meter

Dimension

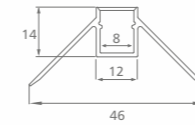

Accessories



End Cap

POP CORNER OUT 1214



POP FLAT 1214



POP CORNER IN 1214



POP CORNER OUT 1214

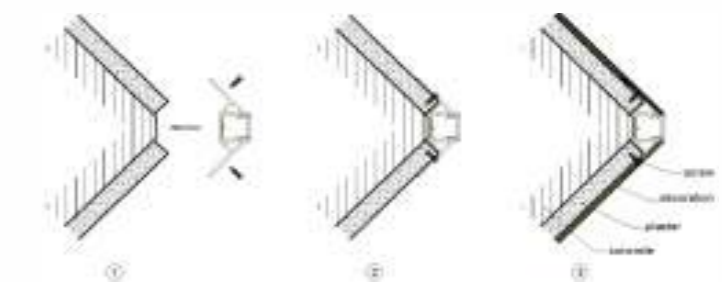

POP (Architectural)

Specifications

Material: Anodized Aluminum
 Diffuser: Frosted Polycarbonate
 Dimension: W: 10mm, H: 35mm
 Light Source: 8mm LED Strip
 Installation: Recessed in Drywall
 Available Length: 3.6 meter

Dimension

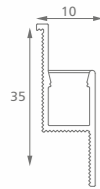

Accessories



End Cap

POP (Architectural)

Specifications

Material: Anodized Aluminum
 Diffuser: Frosted Polycarbonate
 Dimension: W: 25mm (49mm), H: 24mm
 Light Source: 10mm LED Strip
 Installation: POP
 Available Length: 3.6 meter

Dimension

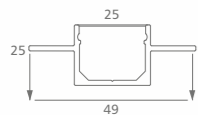

Accessories



End Cap

POP COVE MICRO 1035

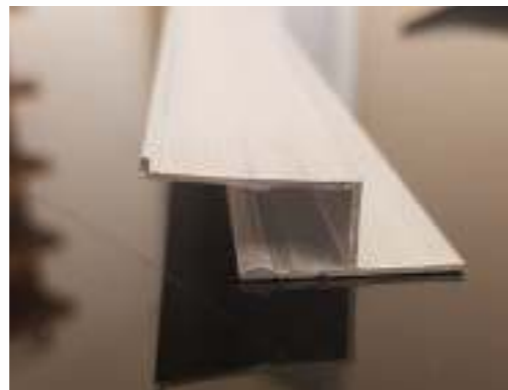

POP (Architectural)

Specifications

Material: Anodized Aluminum
 Diffuser: Frosted Polycarbonate
 Dimension: W: 35mm (65mm), H: 33mm
 Light Source: 10mm LED Strip
 Installation: POP
 Available Length: 3.6 meter

Dimension

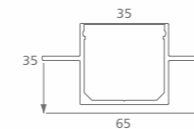

Accessories



End Cap

POP (Architectural)

Specifications

Material: Anodized Aluminum
 Diffuser: Frosted Polycarbonate
 Dimension: W: 50mm (80mm), H: 32mm
 Light Source: 10mm LED Strip
 Installation: POP
 Available Length: 3.6 meter

Dimension

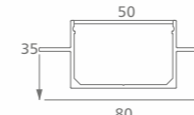

Accessories



End Cap

POP WINGS 3535



POP WINGS 5035



Basic (Kitchen, Wardrobe, Hardware & Retail Display)

LP 0101

Specifications

Material: Anodized Aluminum
 Diffuser: Clear/ Opal or Frosted Polycarbonate
 Dimension: W: 16mm, H: 12mm
 Light Source: 10mm LED Strip
 Installation: Surface Mounted
 Available Length: 3 meter

Dimension

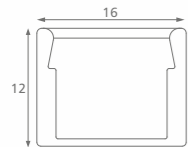

Accessories



End Cap Mounting Clip



Basic (Kitchen, Wardrobe, Hardware & Retail Display)

LP 0102

Specifications

Material: Anodized Aluminum
 Diffuser: Clear/ Opal or Frosted Polycarbonate
 Dimension: W: 22mm (16mm), H: 12mm
 Light Source: 10mm LED Strip
 Installation: Recessed Mounted
 Available Length: 3 meter

Dimension

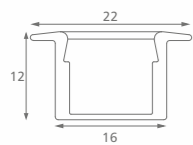

Accessories



End Cap



Basic (Kitchen, Wardrobe, Hardware & Retail Display)

LP 0103

Specifications

Material: Anodized Aluminum
 Diffuser: Clear/ Opal or Frosted Polycarbonate
 Dimension: W: 15.2mm, H: 6mm
 Light Source: 10mm LED Strip
 Installation: Surface Mounted
 Available Length: 3 meter

Dimension

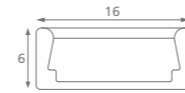

Accessories



End Cap Mounting Clip



Basic (Kitchen, Wardrobe, Hardware & Retail Display)

LP 0104

Specifications

Material: Anodized Aluminum
 Diffuser: Clear/ Opal or Frosted Polycarbonate
 Dimension: W: 22mm (15.2mm), H: 6mm
 Light Source: 10mm LED Strip
 Installation: Recessed Mounted
 Available Length: 3 meter

Dimension

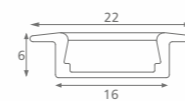

Accessories



End Cap



Basic (Kitchen, Wardrobe, Hardware & Retail Display)

LP 0105

Specifications

Material: Anodized Aluminum
 Diffuser: Clear/ Opal or Frosted Polycarbonate
 Dimension: W: 18.5mm, H: 16mm
 Light Source: 10mm LED Strip
 Installation: Suspended
 Available Length: 3 meter

Dimension

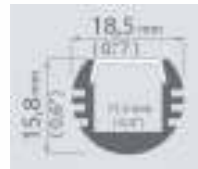

Accessories



End Cap



Basic (Kitchen, Wardrobe, Hardware & Retail Display)

LP 0107

Specifications

Material: Anodized Aluminum
 Diffuser: Clear/ Opal or Frosted Polycarbonate
 Dimension: W: 22mm (16mm), H: 18mm
 Light Source: 10mm LED Strip
 Installation: Recessed Mounted
 Available Length: 3 meter

Dimension

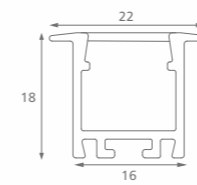

Accessories



End Cap



Basic (Kitchen, Wardrobe, Hardware & Retail Display)

LP 0106

Specifications

Material: Anodized Aluminum
 Diffuser: Clear/ Opal or Frosted Polycarbonate
 Dimension: W: 16mm, H: 18mm
 Light Source: 10mm LED Strip
 Installation: Surface Mounted
 Available Length: 3 meter

Dimension

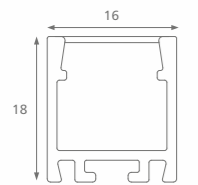

Accessories



End Cap



Mounting Clip



Basic (Kitchen, Wardrobe, Hardware & Retail Display)

LP 0108

Specifications

Material: Anodized Aluminum
 Diffuser: Clear/ Opal or Frosted Polycarbonate
 Dimension: W: 07mm, H: 26mm
 Light Source: 10mm LED Strip
 Installation: Surface Mounted
 Available Length: 3 meter

Dimension

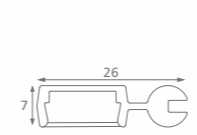

Accessories



End Cap



Mounting Clip



Basic (Kitchen, Wardrobe, Hardware & Retail Display)

LP 0201

Specifications

Material: Anodized Aluminum
 Diffuser: Clear/ Opal or Frosted Polycarbonate
 Dimension: W: 19mm, H: 19mm (45°)
 Light Source: 10mm LED Strip
 Installation: Surface Mounted
 Available Length: 3 meter

Dimension

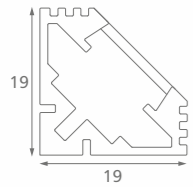

Accessories



End Cap Mounting Clip



Basic (Kitchen, Wardrobe, Hardware & Retail Display)

LP 0205

Specifications

Material: Anodized Aluminum
 Diffuser: Clear/ Opal or Frosted Polycarbonate
 Dimension: W: 18mm, H: 18mm (45°)
 Light Source: 10mm LED Strip
 Installation: Recessed Mounted
 Available Length: 3 meter

Dimension

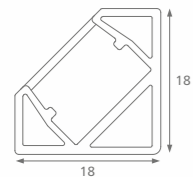

Accessories

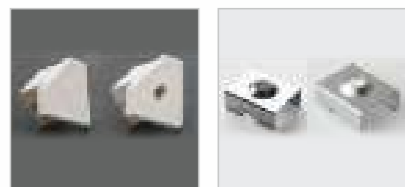

End Cap Mounting Clip



Basic (Kitchen, Wardrobe, Hardware & Retail Display)

LP 0202 R / LP 0202 S

Specifications

Material: Anodized Aluminum
 Diffuser: Clear/ Opal or Frosted Polycarbonate
 Dimension: W: 16mm, H: 16mm (45°)
 Light Source: 8mm LED Strip
 Installation: Surface Mounted
 Available Length: 3 meter

Dimension

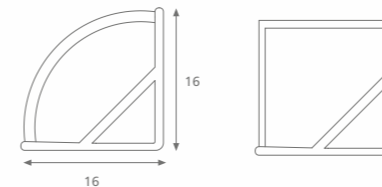

Accessories



End Cap Mounting Clip



Basic (Kitchen, Wardrobe, Hardware & Retail Display)

LP 0204 R / LP 0204 S

Specifications

Material: Anodized Aluminum
 Diffuser: Clear/ Opal or Frosted Polycarbonate
 Dimension: W: 30mm, H: 30mm (45°)
 Light Source: 10mm LED Strip
 Installation: Surface Mounted
 Available Length: 3 meter

Dimension

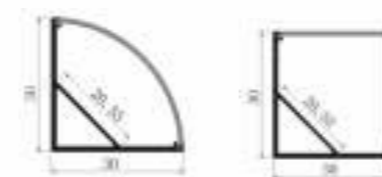

Accessories



End Cap Mounting Clip



Basic (Kitchen, Wardrobe, Hardware & Retail Display)

Specifications

Material: Anodized Aluminum
 Diffuser: Clear/ Opal or Frosted Polycarbonate
 Dimension: W: 57mm, H: 9mm
 Light Source: 10mm x 3 LED Strip
 Installation: Surface/ Recessed Mounted
 Available Length: 3 meter

Dimension

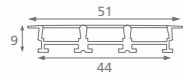

Accessories



End Cap

LP 0301 (TRIPLE)



Basic (Kitchen, Wardrobe, Hardware & Retail Display)

Specifications

Material: Anodized Aluminum
 Diffuser: Clear/ Opal or Frosted Polycarbonate
 Dimension: W: 15mm, H: 30mm
 Light Source: 10mm LED Strip
 Installation: Suspended
 Available Length: 3 meter

Dimension

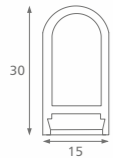

Accessories



End Cap



Mounting Clip

ALS HANGER ROD



Basic (Kitchen, Wardrobe, Hardware & Retail Display)

Specifications

Material: Anodized Aluminum
 Diffuser: Clear/ Opal or Frosted Polycarbonate
 Dimension: W: 32mm, H: 13mm (Angular)
 Light Source: 8mm LED Strip
 Installation: Surface Mounted
 Available Length: 3 meter

Dimension

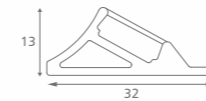

Accessories



End Cap

ALS RETAIL SURFACE



Basic (Kitchen, Wardrobe, Hardware & Retail Display)

Specifications

Material: Anodized Aluminum
 Diffuser: Clear/ Opal or Frosted Polycarbonate
 Dimension: W: 30mm, H: 18mm
 Light Source: 10mm x 2 LED Strip
 Installation: Recessed Mounted
 Available Length: 3.6 meter

Dimension

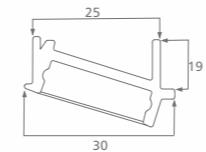

Accessories



End Cap

ALS RETAIL RECESSED-01



Basic (Kitchen, Wardrobe, Hardware & Retail Display)

ALS RETAIL GLASS MOUNTED-01

Specifications

Material: Anodized Aluminum
 Diffuser: Frosted Polycarbonate
 Dimension: W: 26mm, H: 22mm (Glass 8mm & 12mm)
 Light Source: 10mm x 2 LED Strip
 Installation: Surface Mounted
 Available Length: 3.6 meter

Dimension

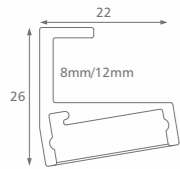

ALS GLASS SHELF RECESSED

Specifications

Material: Anodized Aluminum
 Diffuser: Frosted Polycarbonate
 Dimension: W: 34mm, H: 70mm
 Light Source: 10mm LED Strip
 Installation: Recessed Mounted
 Available Lengths: 2m, 2.5m, 3m

Dimension

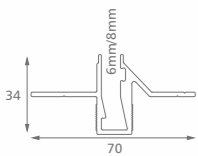

ALS GLASS SHELF SURFACE

Specifications

Material: Anodized Aluminum
 Diffuser: Frosted Polycarbonate
 Dimension: W: 32mm, H: 30mm
 Light Source: 10mm LED Strip
 Installation: Surface Mounted
 Available Lengths: 2m, 2.5m, 3m

Dimension

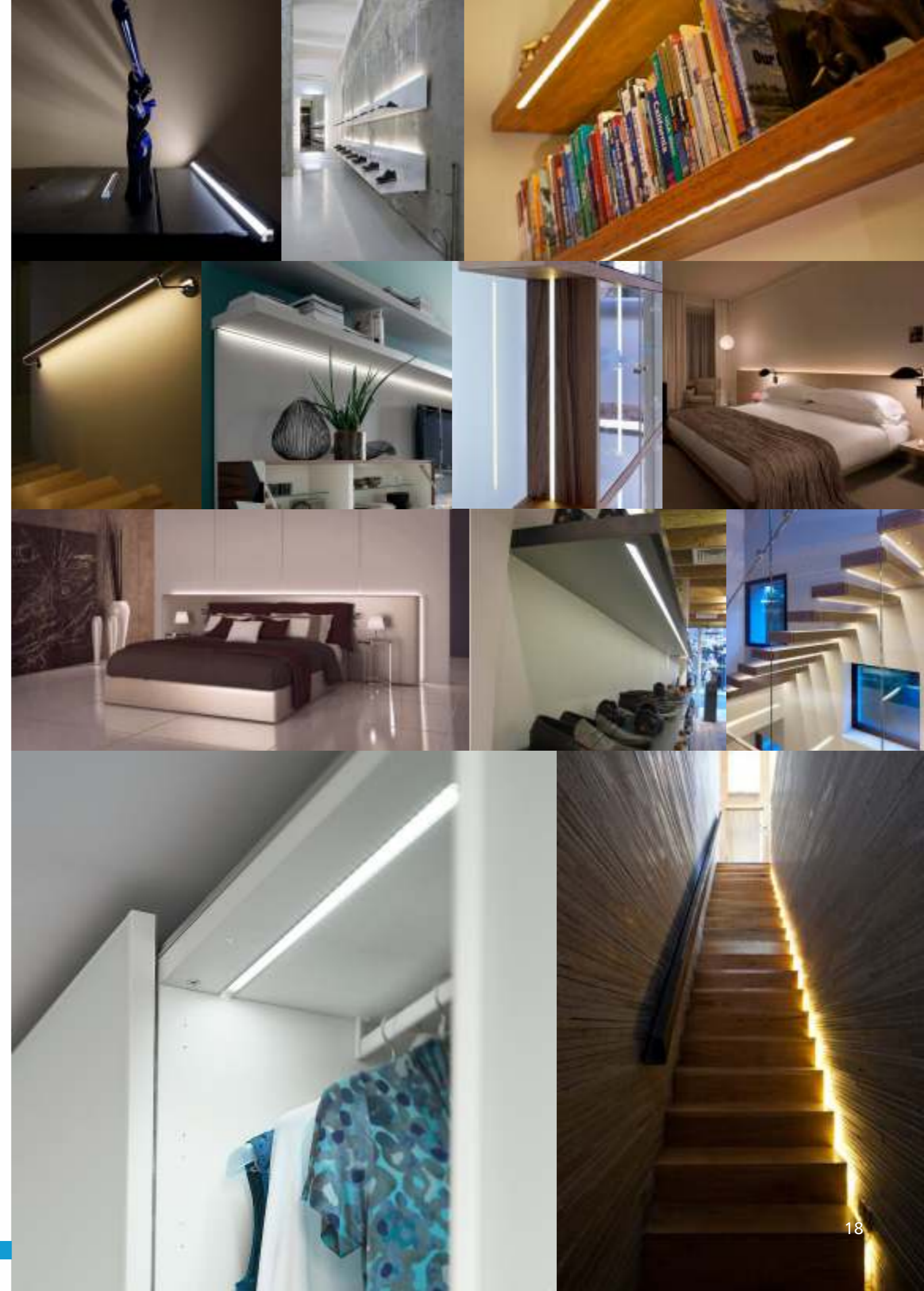
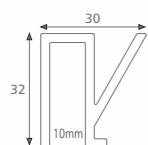

Economic



Economic

Specifications

Material: Anodized Aluminum
 Diffuser: Frosted Polycarbonate
 Dimension: W: 23.6mm, H: 12mm
 Light Source: 10mm x 2 LED Strip
 Installation: Surface Mounted
 Available Length: 3.6 meter

Dimension

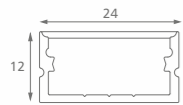

Accessories



End Cap Mounting Clip

Economic

Specifications

Material: Anodized Aluminum
 Diffuser: Frosted Polycarbonate
 Dimension: W: 23.6mm, H: 18mm
 Light Source: 10mm x 2 LED Strip
 Installation: Surface Mounted
 Available Length: 3.6 meter

Dimension

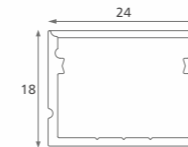

Accessories

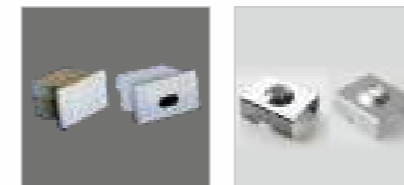

End Cap Mounting Clip

Economic

Specifications

Material: Anodized Aluminum
 Diffuser: Frosted Polycarbonate
 Dimension: W: 30.6mm (23.6), H: 20mm
 Light Source: 10mm x 2 LED Strip
 Installation: Recessed Mounted
 Available Length: 3.6 meter

Dimension

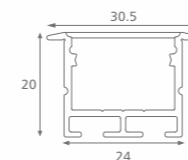

Accessories



End Cap Mounting Clip

ECO 2518

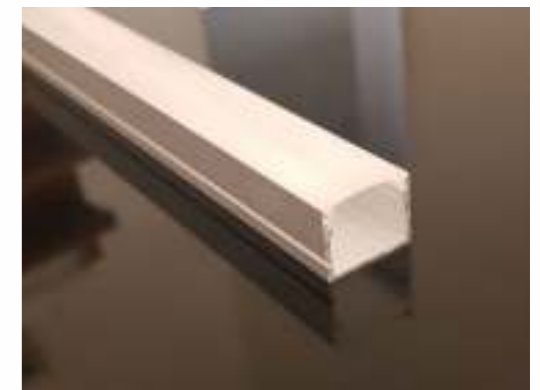

ECO 2520 TRIM



Economic

Specifications

Material: Anodized Aluminum
 Diffuser: Frosted Polycarbonate
 Dimension: W: 35mm, H: 35mm
 Light Source: 10mm x 3 LED Strip
 Installation: Surface/ Suspended Mounted
 Available Length: 3.6 meter

Dimension

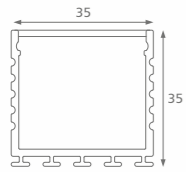

Accessories



End Cap

ECO 3535

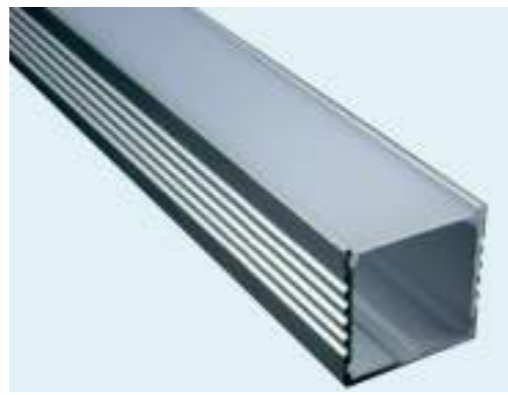

Economic

Specifications

Material: Anodized Aluminum
 Diffuser: Frosted Polycarbonate
 Dimension: W: 50mm, H: 35mm
 Light Source: 10mm x 3 LED Strip
 Installation: Surface/ Suspended Mounted
 Available Length: 3.6 meter

Dimension

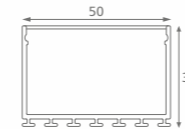

Accessories



End Cap

ECO 5035



Economic

Specifications

Material: Anodized Aluminum
 Diffuser: Frosted Polycarbonate
 Dimension: W: 46mm (35mm), H: 35mm
 Light Source: 10mm x 3 LED Strip
 Installation: Recessed Mounted
 Available Length: 3.6 meter

Dimension

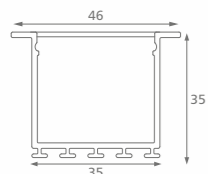

Accessories



End Cap



Mounting Clip

ECO 3535 TRIM

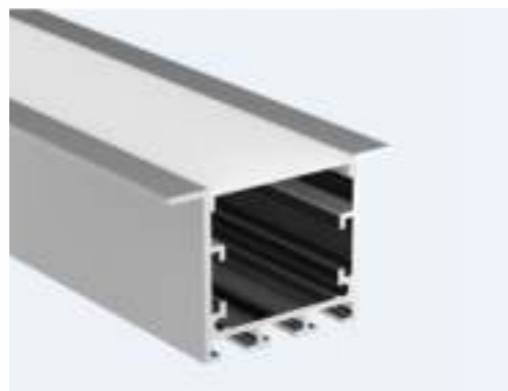

Economic

Specifications

Material: Anodized Aluminum
 Diffuser: Frosted Polycarbonate
 Dimension: W: 65mm (50mm), H: 35mm
 Light Source: 10mm x 3 LED Strip
 Installation: Recessed Mounted
 Available Length: 3.6 meter

Dimension

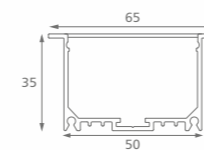

Accessories



End Cap



Mounting Clip

ECO 5035 TRIM



Economic

Specifications

Material: Anodized Aluminum
 Diffuser: Frosted Polycarbonate
 Dimension: W: 75mm, H: 35mm
 Light Source: 10mm x 3/4 LED Strip
 Installation: Surface Mounted
 Available Length: 3.6 meter

Dimension

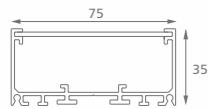

Accessories



End Cap

ECO 7535



Economic

Specifications

Material: Anodized Aluminum
 Diffuser: Frosted Three Side Polycarbonate
 Dimension: W: 50mm, H: 70mm
 Light Source: 10mm x 2/3 LED Strip
 Installation: Surface/ Suspended Mounted
 Available Length: 3.6 meter

Dimension

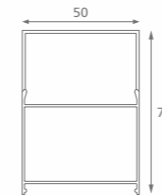

Accessories



End Cap

ECO 5070 3D



Economic

Specifications

Material: Anodized Aluminum
 Diffuser: Frosted Polycarbonate
 Dimension: W: 90mm (75mm), H: 35mm
 Light Source: 10mm x 3/4 LED Strip
 Installation: Recessed Mounted
 Available Length: 3.6 meter

Dimension

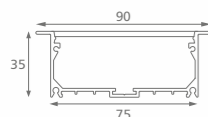

Accessories



End Cap



Mounting Clip

ECO 7575 TRIM



Economic

Specifications

Material: Anodized Aluminum
 Diffuser: Frosted Polycarbonate
 Dimension: W: 50mm, H: 70mm
 Light Source: 10mm x 2/3 LED Strip
 Installation: Surface/ Suspended Mounted
 Available Length: 3.6 meter

Dimension

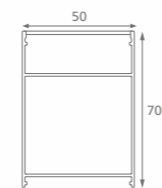

Accessories



End Cap

ECO 5070 FLAT



Economic

Specifications

Material: Anodized Aluminum
Diffuser: Frosted Polycarbonate
Dimension: W: 70mm, H: 90mm
Light Source: 10mm x 2/3 LED Strip
Installation: Surface/ Suspended Mounted
Available Length: 3.6 meter

Dimension

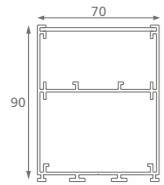

Accessories



End Cap

ECO 7090



Architecture (Interior Design)

Specifications

Material: Anodized Aluminum
 Diffuser: Polycarbonate
 Dimension: W: 26.5mm, H: 29mm
 Light Source: 10mm LED Strip
 Installation: Surface Mounted
 Available Length: 3.6 meter

Dimension

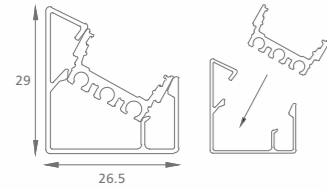

Accessories



End Cap

Architecture (Interior Design)

Specifications

Material: Anodized Aluminum
 Diffuser: Polycarbonate
 Dimension: W: 29mm, H: 26.5mm
 Light Source: 10mm LED Strip
 Installation: Surface Mounted
 Available Length: 3.6 meter

Dimension

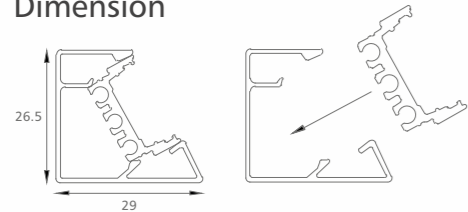

Accessories



End Cap

CORNER 30°



Architecture (Interior Design)

Specifications

Material: Anodized Aluminum
 Diffuser: Polycarbonate
 Dimension: W: 32mm, Cutout +25mm, H: 33mm
 Light Source: 13mm LED Strip
 Installation: Recessed Mounted
 Available Length: 3.6 meter

Dimension

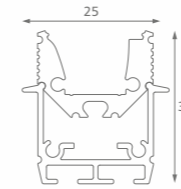

Accessories



End Cap

Architecture (Interior Design)

Specifications

Material: Anodized Aluminum
 Diffuser: Polycarbonate
 Dimension: W: 25mm, H: 30mm
 Light Source: 13mm LED Strip
 Installation: Surface Mounted
 Available Length: 3.6 meter

Dimension

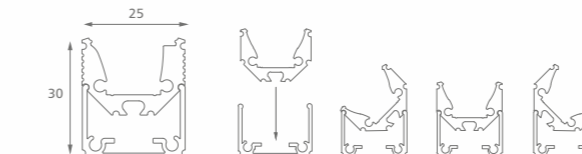

Accessories



End Cap

WALL WASHER ASYMMETRIC RECESSED



WALL WASHER ASYMMETRIC SURFACE



Architecture (Interior Design)

Specifications

Material: Anodized Aluminum Profile
 Diffuser: 2 Side "L" Polycarbonate
 Dimension: W: 50, H: 51mm
 Light Source: 10mm x 2 LED Strip
 Installation: Surface Mounted
 Available Length: 3.6 meter

Dimension

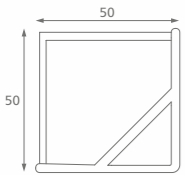

Accessories



End Cap



Mounting Clip

BIG CORNER 5050



Architecture (Interior Design)

Specifications

Material: Anodized Aluminum
 Diffuser: Polycarbonate
 Dimension: W: 33mm, H: 57mm
 Light Source: 10mm x 2 LED Strip
 Installation: Surface Mounted
 Available Length: 3.6 meter

Dimension

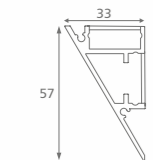

Accessories



End Cap



Mounting Clip

WALL LIGHT LP 0501



Architecture (Interior Design)

Specifications

Material: Anodized Aluminum
 Diffuser: Polycarbonate
 Dimension: W: 65mm, H: 26mm
 Light Source: 10mm x 2 LED Strip
 Installation: Surface Mounted
 Available Length: 3.6 meter

Dimension

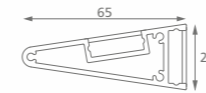

Accessories



End Cap



Mounting Clip

WALL LIGHT LP 0502



Architecture (Interior Design)

Specifications

Material: Anodized Aluminum
 Diffuser: Polycarbonate
 Dimension: W: 32mm, H: 25mm
 Light Source: 10mm x 2 LED Strip
 Installation: Surface Mounted
 Available Length: 3.6 meter

Dimension

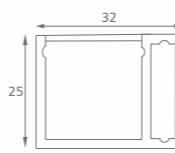

Accessories



End Cap



Mounting Clip

WALL LIGHT LP 0503



Architecture (Interior Design)

Specifications

Material: Anodized Aluminum
 Diffuser: Polycarbonate
 Dimension: W: 35mm, H: 85mm
 Light Source: 10mm x 2+10mm x 2 LED Strip
 Installation: Surface Mounted
 Available Length: 3.6 meter

Dimension

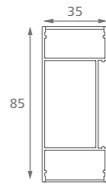

Accessories



End Cap Mounting Clip

Architecture (Interior Design)

Specifications

Material: Anodized Aluminum
 Diffuser: Polycarbonate
 Dimension: W: 42mm, H: 41mm
 Light Source: 10mm LED Strip
 Installation: Surface Mounted
 Available Length: 3 meter

Dimension



Accessories



Mounting Clip

Architecture (Interior Design)

Specifications

Material: Anodized Aluminum
 Diffuser: Polycarbonate
 Dimension: W: 32mm, Cutout +72mm, H: 80mm
 Installation: Recessed Mounted
 Available Length: 3.6 meter

Dimension



Accessories



End Cap

Architecture (Interior Design)

Specifications

Material: Anodized Aluminum
 Diffuser: Polycarbonate
 Dimension: W: 55mm, H: 21mm
 Installation: Surface Mounted
 Available Length: 3 meter

Dimension

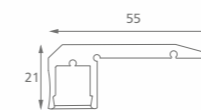

Accessories



End Cap

WALL UP DOWN

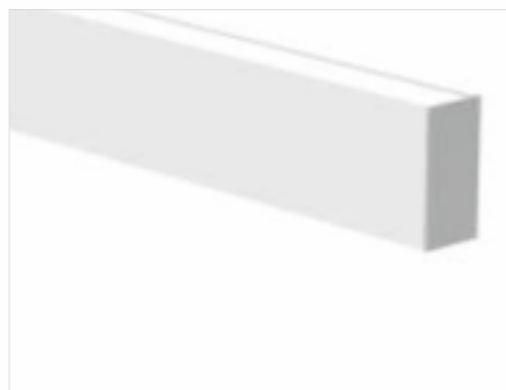

ALS FOOT LIGHT LP 0701



HAND RAILING



ALS STEP LIGHT LP 0702



Architecture (Interior Design)

Specifications

Material: Anodized Aluminum
 Diffuser: Polycarbonate
 Dimension: W: 15mm, H: 58mm
 Light Source: 10mm LED Strip
 Installation: Surface Mounted
 Available Length: 3 meter

Dimension

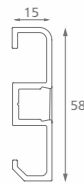

Accessories



End Cap

ALS SKIRTING 50MM LP 0703



Architecture (Interior Design)

Specifications

Material: Anodized Aluminum
 Diffuser: Polycarbonate
 Dimension: W: 35mm, H: 45mm
 Installation: Before P.O.P
 Available Length: 3.6 meter

Dimension

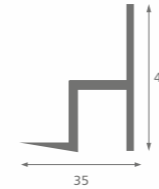

Accessories



End Cap

ALS COVE LP 0901



Architecture (Interior Design)

Specifications

Material: Anodized Aluminum
 Diffuser: Polycarbonate
 Dimension: W: 30mm, H: 106mm
 Installation: Surface Mounted
 Available Length: 3 meter

Dimension

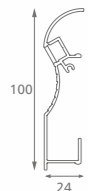

Accessories

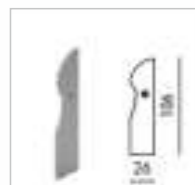

End Cap

SKIRTING WALL WASH LP 0704



Architecture (Interior Design)

Specifications

Material: Anodized Aluminum
 Diffuser: Polycarbonate
 Dimension: W: 35mm, H: 70mm
 Installation: Before P.O.P
 Available Length: 3.6 meter

Dimension



Accessories



End Cap

ALS DEEP COVE LP 0903



Architecture (Interior Design)

Specifications

Material: Base Anodized Aluminum
 Diffuser: 3 Side Polycarbonate
 Dimension: W: 25mm, H: 25mm
 Installation: Surface, Suspended
 Available Length: 3.6 meter

Dimension

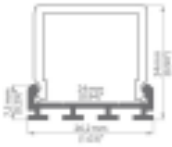

Accessories



End Cap

Architecture (Interior Design)

Specifications

Material: Anodized Aluminum
 Diffuser: 2 PCS Polycarbonate
 Dimension: W: 30mm, H: 40mm
 Installation: Surface
 Available Length: 3.6 meter

Dimension

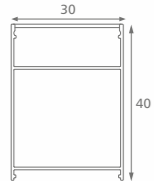

Accessories



End Cap

Architecture (Interior Design)

Specifications

Material: Anodized Aluminum
 Diffuser: Thick Polycarbonate
 Dimension: W: 21.3mm, H: 12mm
 Installation: Recessed Mounted
 Available Length: 3.6 meter

Dimension



Accessories



End Cap

Architecture (Interior Design)

Specifications

Material: Anodized Aluminum
 Diffuser: Thick Polycarbonate
 Dimension: W: 21.3mm, H: 26mm
 Installation: Recessed
 Available Length: 3.6 meter

Dimension

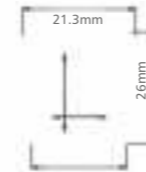

Accessories

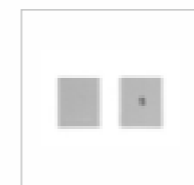

End Cap

ALS 2525 3D



FLOOR INDOOR SMALL



WALL UP-DOWN LP 0505

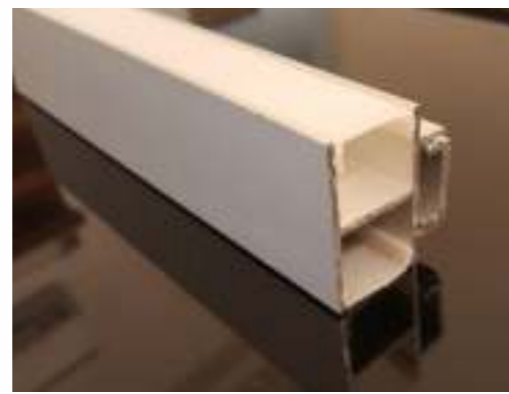

FLOOR INDOOR BIG





Premium General Lighting

Specifications

Material: Anodized Aluminum
 Diffuser: Polycarbonate
 Dimension: W: 15mm, H: 30mm
 Installation: Surface, Suspended
 Available Length: 3.6 meter

Dimension

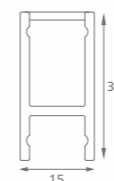

Accessories



End Cap

LINEA 1530



Premium General Lighting

Specifications

Material: Anodized Aluminum
 Diffuser: Polycarbonate
 Dimension: W: 23mm, Cutout +15mm, H: 25mm
 Installation: Recessed
 Available Length: 3.6 meter

Dimension

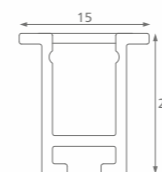

Accessories



End Cap



Mounting Clip

LINEA 1525 TRIM



Premium General Lighting

Specifications

Material: Anodized Aluminum
 Diffuser: Polycarbonate
 Dimension: W: 25mm, H: 25mm
 Installation: Surface, Suspended
 Available Length: 3.6 meter

Dimension

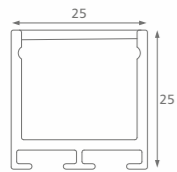

Accessories



End Cap

LINEA 2525



Premium General Lighting

Specifications

Material: Anodized Aluminum
 Diffuser: Polycarbonate
 Dimension: W: 32mm, Cutout +25mm, H: 25mm
 Installation: Recessed
 Available Length: 3.6 meter

Dimension

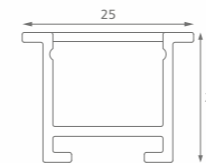

Accessories



End Cap



Mounting Clip

LINEA 2525 TRIM

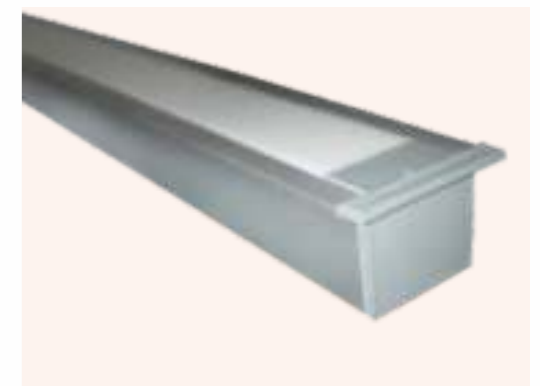

Premium General Lighting

Specifications

Material: Anodized Aluminum
 Diffuser: Polycarbonate
 Dimension: W: 25mm, H: 30mm
 Installation: Surface, Suspended
 Available Length: 3.6 meter

Dimension

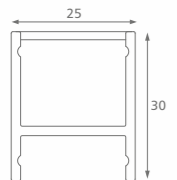

Accessories



End Cap



Mounting Clip

LINEA 2530

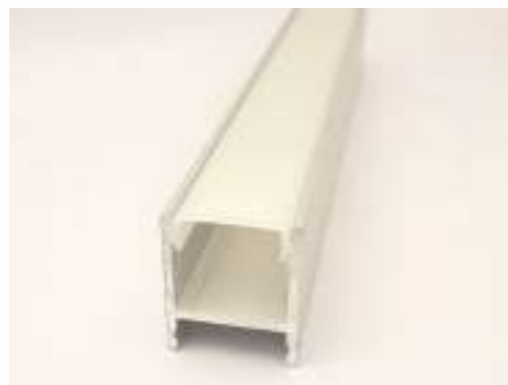

Premium General Lighting

Specifications

Material: Anodized Aluminum
 Diffuser: Frosted Polycarbonate
 Dimension: W: 41mm, Cutout +30mm, H: 50mm
 Installation: Recessed Mounted
 Available Length: 3.6 meter

Dimension

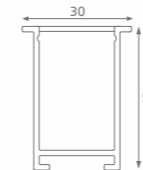

Accessories



End Cap



Mounting Clip

LINEA 3050 TRIM



Premium General Lighting

Specifications

Material: Anodized Aluminum
 Diffuser: Polycarbonate
 Dimension: W: 50mm, H: 50mm
 Installation: Surface, Suspended
 Available Length: 3.6 meter

Dimension

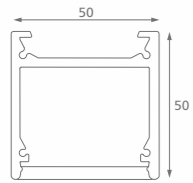

Accessories



End Cap

LINEA 5050



Premium General Lighting

Specifications

Material: Anodized Aluminum
 Diffuser: Polycarbonate
 Dimension: W: 60mm, H: 80mm
 Installation: Surface, Suspended
 Available Length: 3.6 meter

Dimension

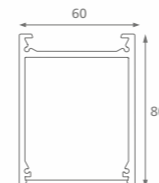

Accessories



End Cap

LINEA 6080

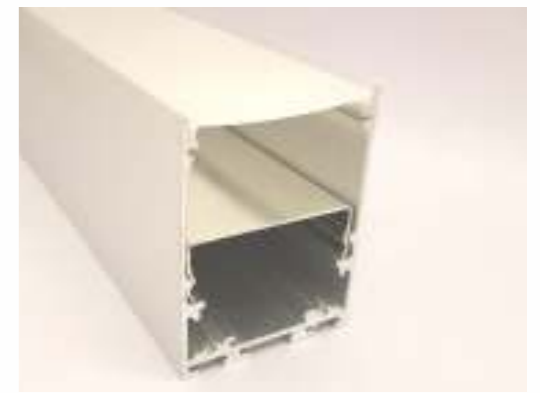

Premium General Lighting

Specifications

Material: Anodized Aluminum
 Diffuser: Polycarbonate
 Dimension: W: 65mm, Cutout +50mm, H: 50mm
 Installation: Recessed
 Available Length: 3.6 meter

Dimension

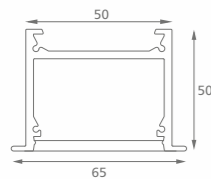

Accessories



End Cap



Mounting Clip

LINEA 5050 TRIM



Premium General Lighting

Specifications

Material: Anodized Aluminum
 Diffuser: Polycarbonate
 Dimension: W: 77, Cutout +60mm, H: 80mm
 Installation: Recessed Mounted
 Available Length: 3.6 meter

Dimension

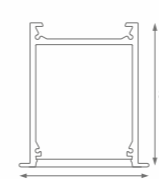

Accessories



End Cap



Mounting Clip

LINEA 7780 TRIM



Premium General Lighting

Specifications

Material: Anodized Aluminum
 Diffuser: Polycarbonate
 Dimension: W: 48, H: 48mm
 Installation: Surface, Suspended
 Available Length: 3.6 meter

Dimension

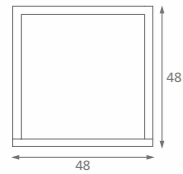

Accessories



End Cap

LINEA 4848



Premium General Lighting

Specifications

Material: Anodized Aluminum
 Diffuser: Polycarbonate
 Dimension: W: 48mm, H: 100mm
 Installation: Suspended
 Available Length: 3.6 meter

Dimension



Accessories



End Cap

LINEA 48100 UP DOWN



Premium General Lighting

Specifications

Material: Anodized Aluminum
 Diffuser: Polycarbonate
 Dimension: W: 48mm, H: 70mm
 Installation: Surface, Suspended
 Available Length: 3.6 meter

Dimension

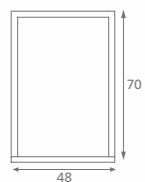

Accessories



End Cap

LINEA 4870



Premium General Lighting

Specifications

Material: Anodized Aluminum
 Diffuser: Polycarbonate
 Dimension: W: 90mm, H: 100mm
 Installation: Surface, Suspended
 Available Length: 3.6 meter

Dimension

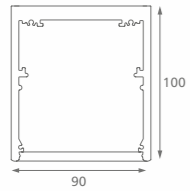

Accessories



End Cap

LINEA 90100



Premium General Lighting

Specifications

Material: Anodized Aluminum
 Diffuser: Polycarbonate
 Dimension: W: 90mm, H: 136mm
 Installation: Up-Down Suspended
 Available Length: 3.6 meter

Dimension

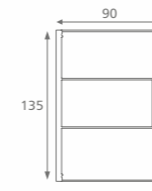

Accessories



End Cap

LINEA 90136 UP DOWN

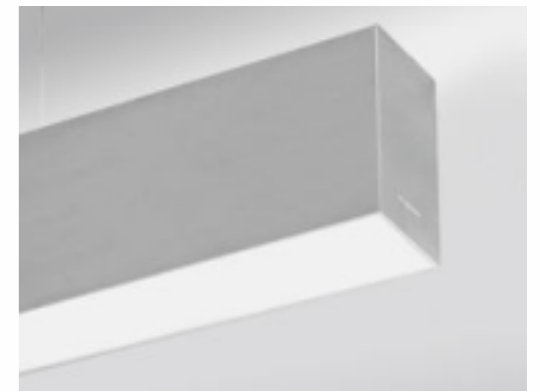

Premium General Lighting

Specifications

Material: Anodized Aluminum
 Diffuser: Polycarbonate
 Dimension: W: 112mm, Cutout +90mm, H: 100mm
 Installation: Recessed Mounted
 Available Length: 3.6 meter

Dimension

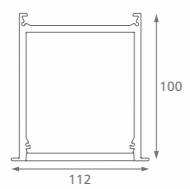

Accessories



End Cap



Mounting Clip

LINEA 112100 TRIM



Premium General Lighting

Specifications

Material: Anodized Aluminum
 Diffuser: Polycarbonate
 Dimension: W: 135mm, H: 90mm
 Installation: Techzone, Recessed Surface, Suspended
 Available Length: 3.6 meter

Dimension

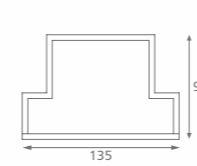

Accessories



End Cap

LINEA 13590



Premium General Lighting

Specifications

Material: Anodized Aluminum
 Diffuser: Polycarbonate
 Dimension: W: 100mm, H: 20mm
 Installation: Suspended
 Available Length: 3.6 meter

Dimension

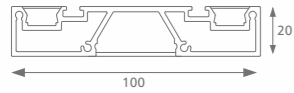

Accessories



End Cap

Premium General Lighting

Specifications

Material: Base Anodized Aluminum
 Diffuser: 3 side Polycarbonate
 Dimension: W: 54mm, H: 80mm
 Installation: Surface, Suspended
 Available Length: 3.6 meter

Dimension

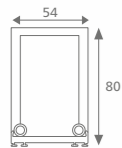

Accessories



End Cap

LINEA 10020 UP DOWN SUSPENDED



GLOW 3D





NEW
FURNITURE
LIGHTING

SHELF PROFILE MINI

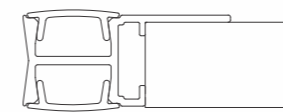
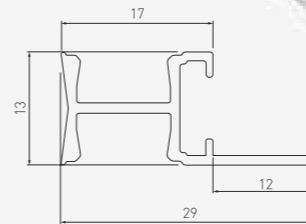
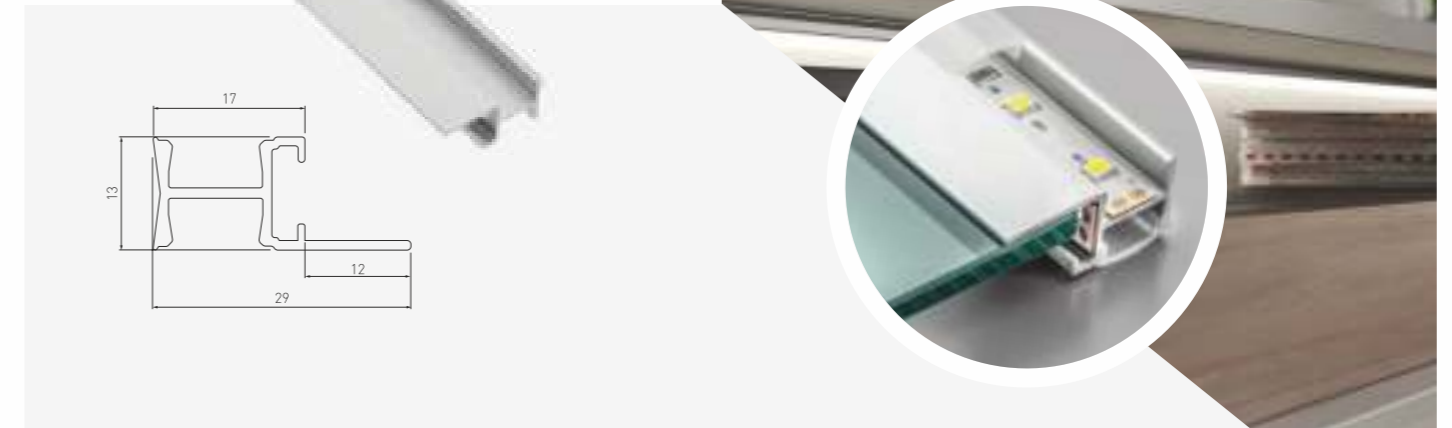

RIM PROFILE

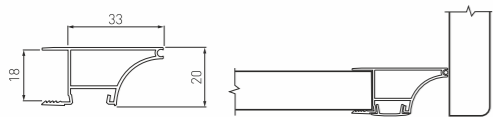

EDGE PROFILE-RECESSED

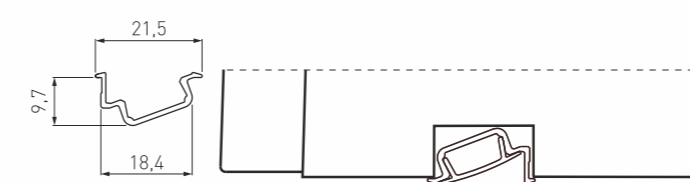

EDGE PROFILE-SINGLE-SIDED

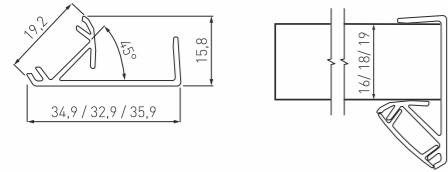

EDGE PROFILE-DOUBLE-SIDED

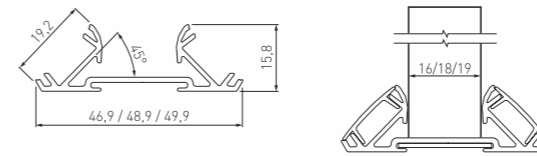

EDGE PROFILE-SINGLE-SIDED
(OPTION TO FILL WITH MATCHING EDGE BANDING)

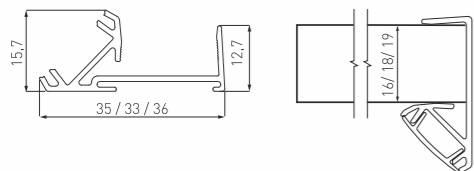

EDGE PROFILE-DOUBLE-SIDED
(OPTION TO FILL WITH MATCHING EDGE BANDING)

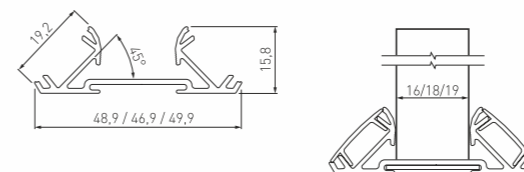

EDGE PROFILE-SINGLE-SIDED, NARROW

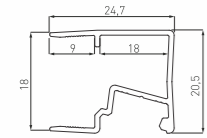

EDGE PROFILE-DOUBLE-SIDED, NARROW

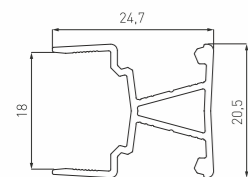
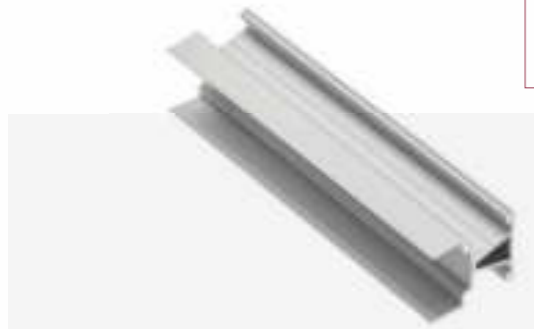

ENCAPSULED

Encapsulated IP Rated Linear LED Lights



- LED Profiles In Aluminum
- Stainless Steel
- Polyurethane Flexible
- Ingress Protection upto IP 68
- Facade, Walk over & Drive over
- Custom Lengths
- Custom Colour Temperatures
- Custom Wattages
- Different Shore Hardness Available
- Manufacturers of IP68 Gel Connectors



European Technology, Machinery & Raw Material
Made in India

ENCAPSULED

Encapsulated IP Rated Linear LED Lights



EL - OVER STAINLESS STEEL

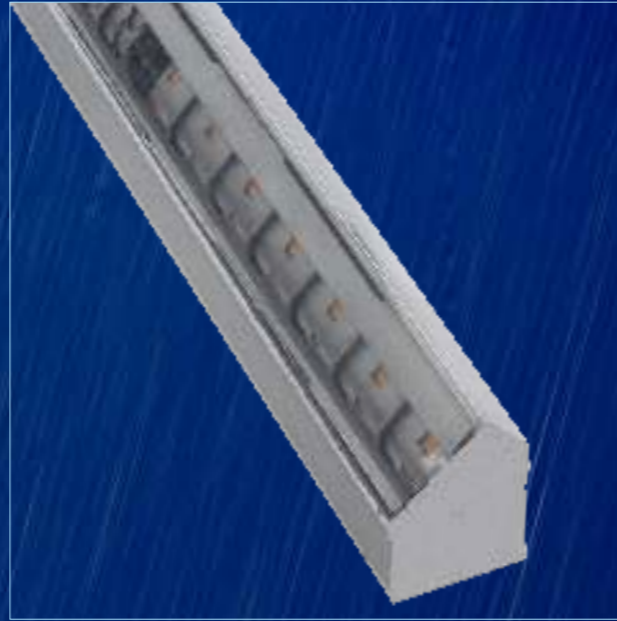

EL - TILT ASYMMYTRIC

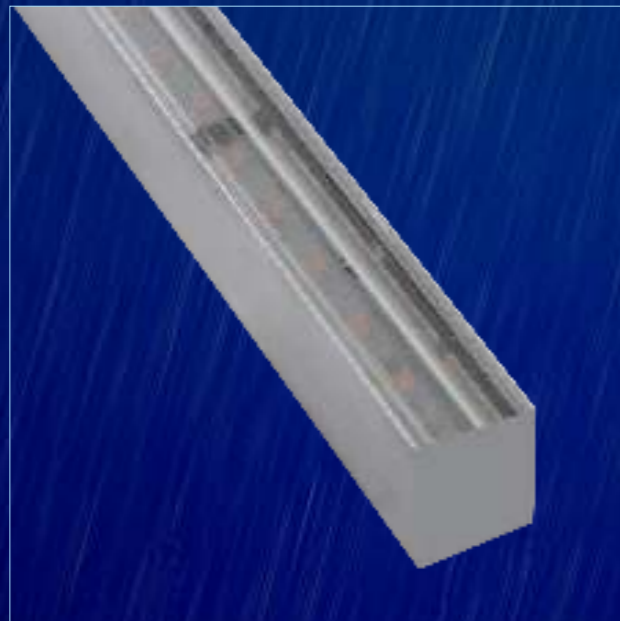

EL - OPTICS 10°/30°/60°



EL-R CORNER 30° 60°

European Technology, Machinery & Raw Material
Made in India

ENCAPSULED

Encapsulated IP Rated Linear LED Lights



European Technology, Machinery & Raw Material
Made in India